



ISO TC184 SC4 Semantics and STEP Information Models

NIST Ontology Summit April 2009

David Price Eurostep and Allison Feeney NIST



COPYRIGHT EUROSTEP GROUP

NIST

National Institute of Standards and Technology
Technology Administration, U.S. Department of Commerce

Agenda

1. ISO 10303 STEP and OASIS PLCS use of OWL as Reference Data for data exchange
2. NIST “Future STEP” Project semantics thread

Part 1: OASIS PLCS and ISO 10303 STEP use of OWL as Reference Data for data exchange

The Approach to the PLCS/AP233 standards

- » In ISO : Standardize flexible information model, less strongly typed than traditional ISO STEP schemas
 - Modelled ability to say **isMemberOf** and **SameAs** as part of schema
 - » Did not change the EXPRESS modelling language
 - 200+ information model concepts require Reference Data
 - » Reference Data is their term for an “external” ontology
- » Separately : standardize user guides and Reference Data
 - OASIS PLCS Technical Committee formed for this purpose
- » Enable non-standard Reference Data extensions
 - Enables further tailoring and contracting for standards-based exchange between partners

Requirement 1

Dot end
is subclass

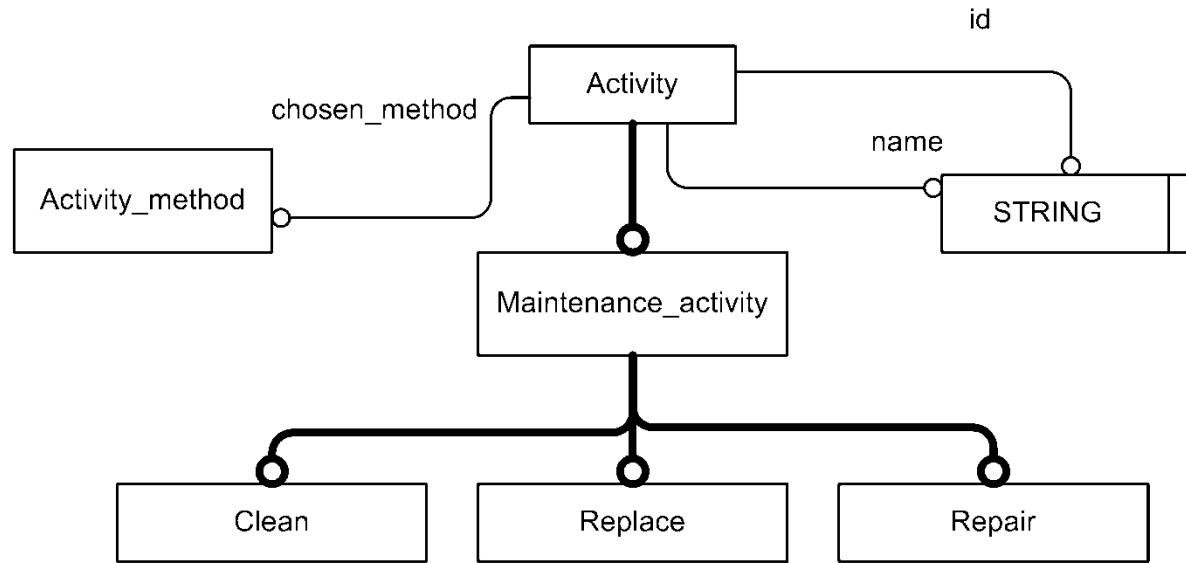

ISO Information Model

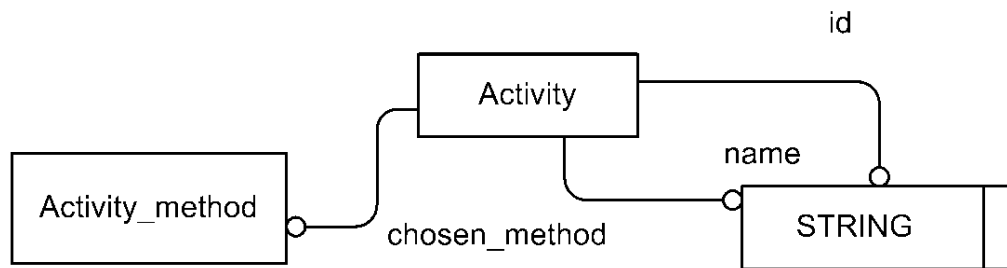

External Classes

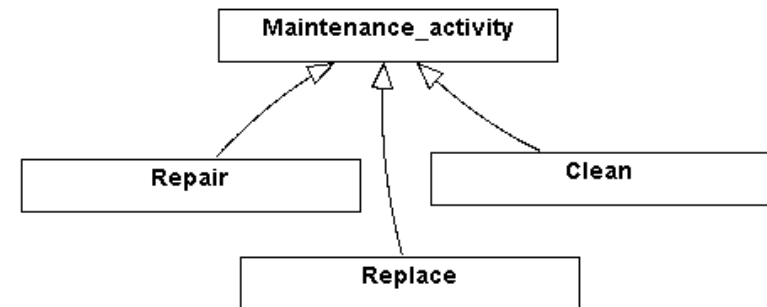

Requirement 2

Hour is an instance of **Unit**

Hour

OWL Ontology

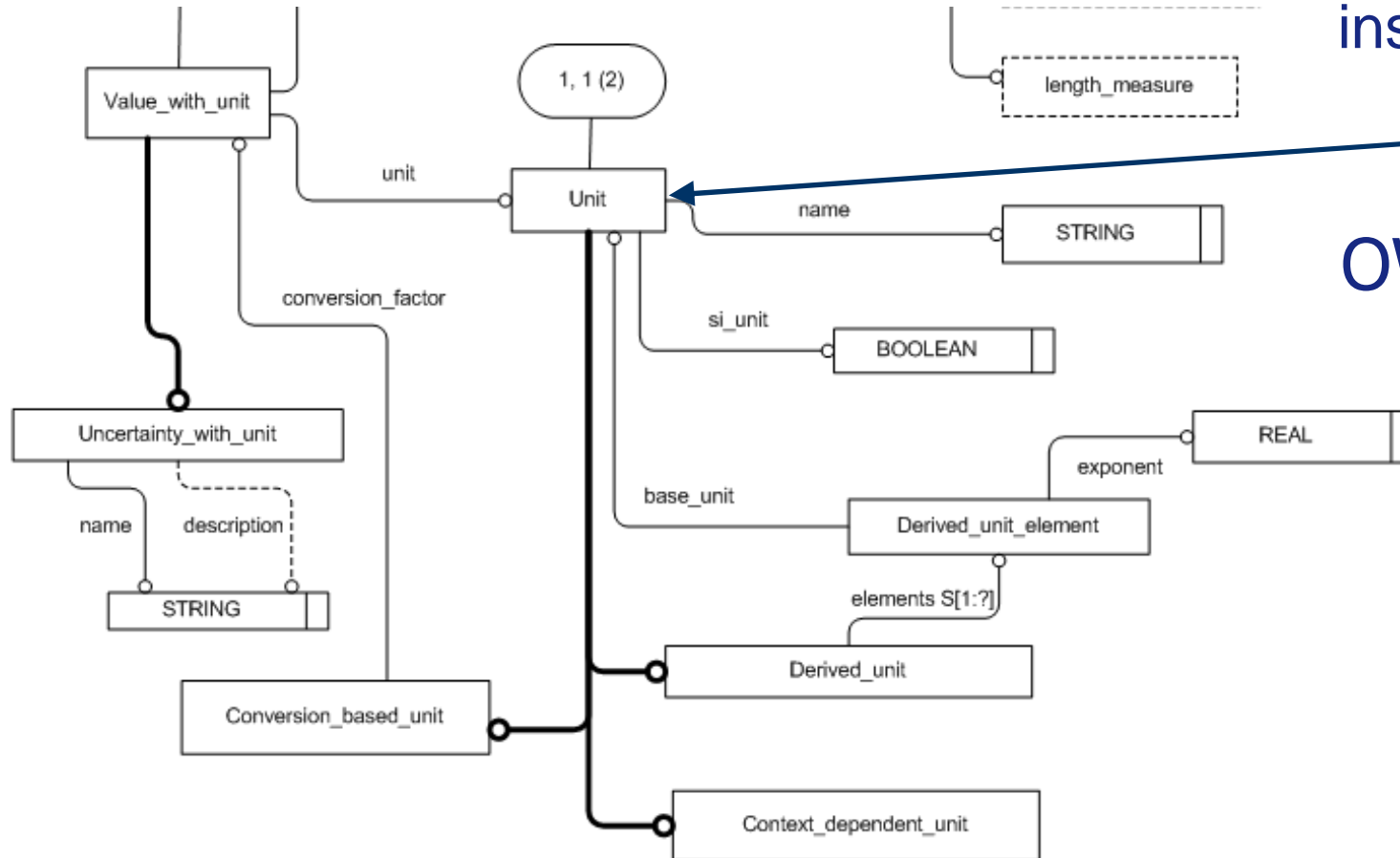

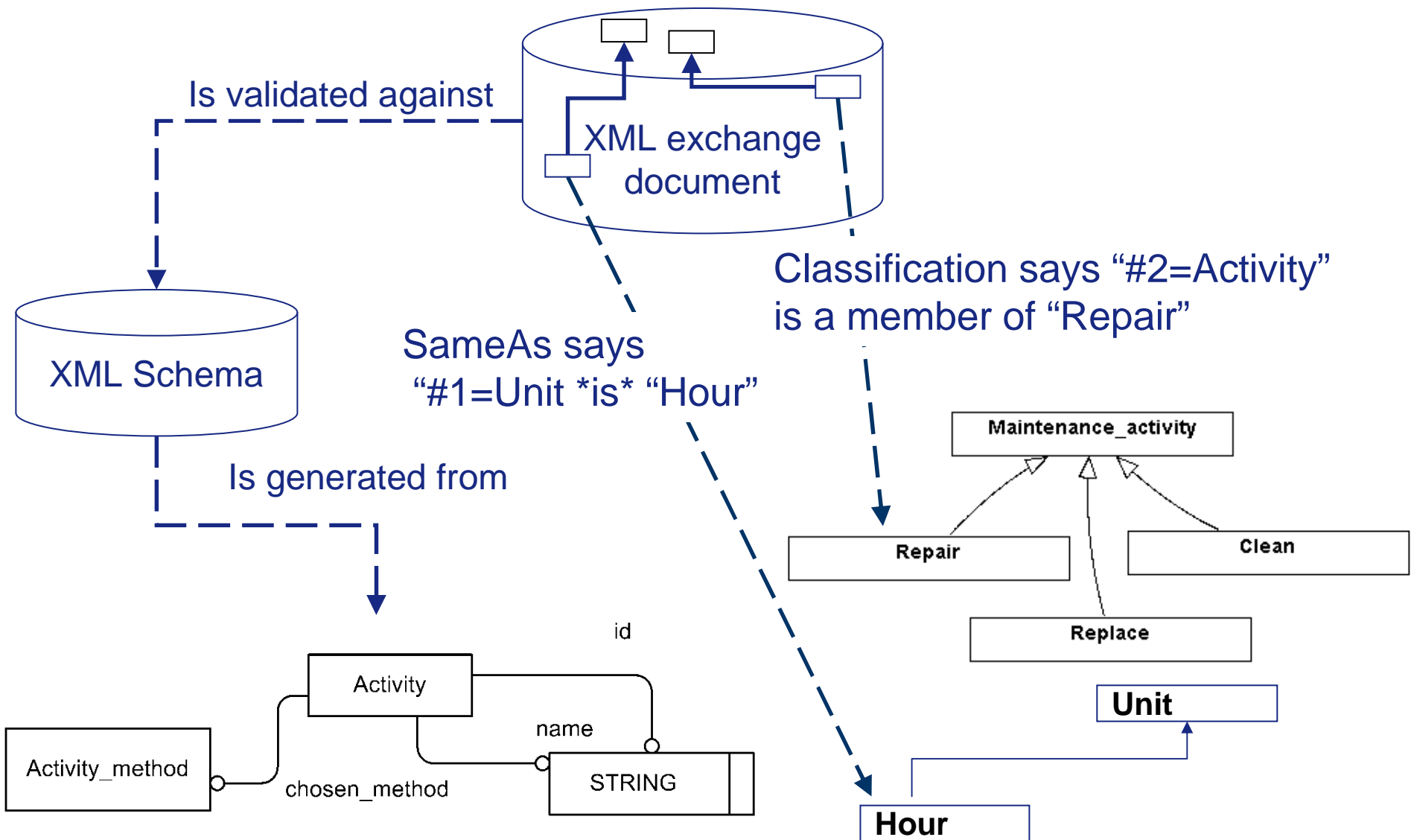

ISO Information Model

OWL Ontology

Techniques to make this work

- » Adopt OWL for Reference Data
 - Use Dublin Core annotations for Reference Data

- » Convert ISO EXPRESS entity types schema to OWL classes
 - Purely structural EXPRESS to OWL mapping implemented in 2003
 - » Based on 2003 October paper - *A Brief Foray into Semantic Web Technology and STEP*

- » Specify relationship between ISO EXPRESS-driven OWL classes and Reference Data classes
 - Is Subclass Of
 - » **CriticalRequirement** is kind of **Requirement**
 - Individuals
 - » **Hour** is instance of **Unit**

- » Need diagram notation – OMG helps here

Use OWL and EXPRESS Profile together

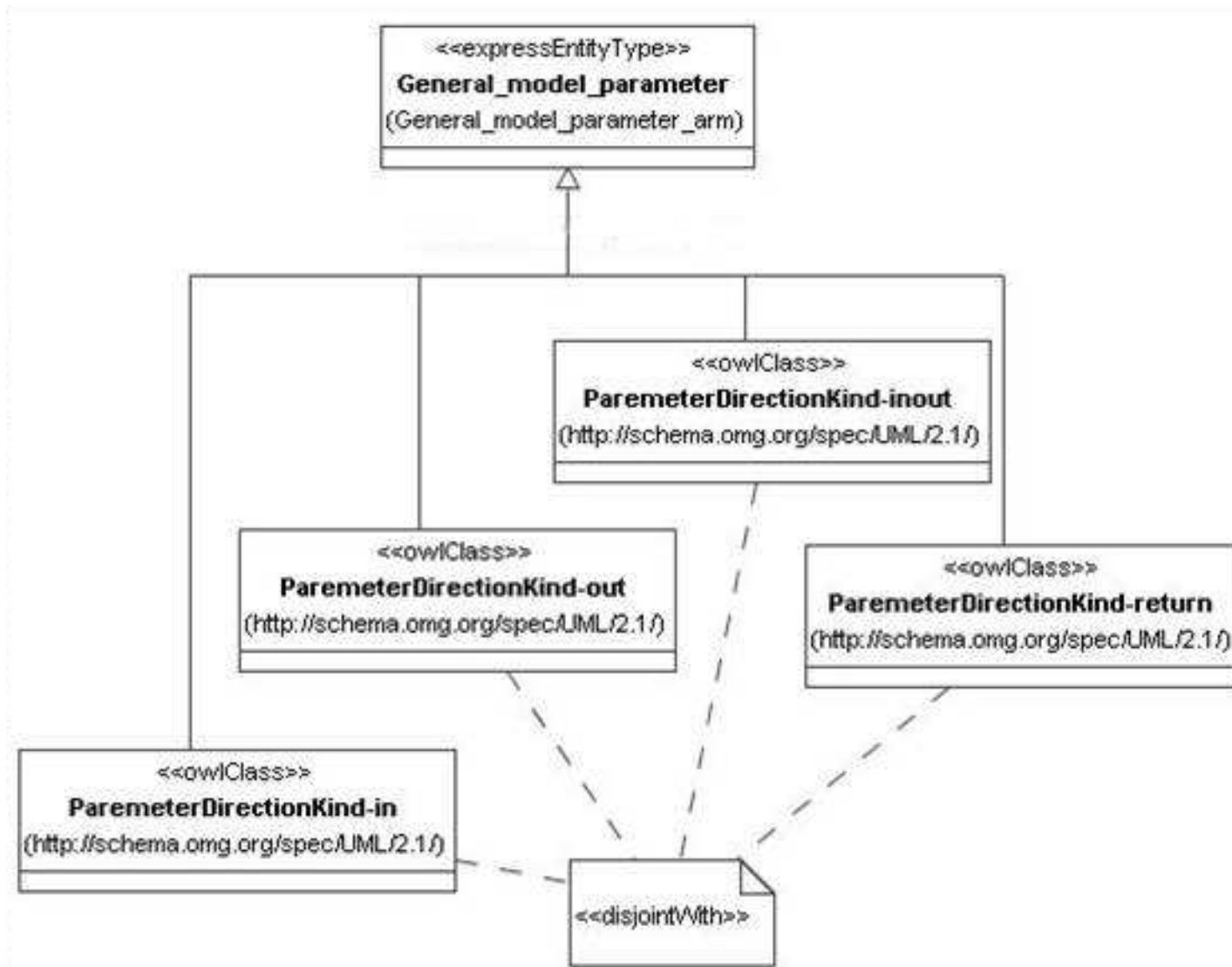

Conclusions

- » Many sources of Reference Data being recast as OWL, or at least URIs are being assigned
 - Including OMG UML and SysML specifications as part of SysML/AP233 Systems Engineering mapping
 - OASIS TC harvesting many specs for Product Life Cycle Support

- » Success of ISO STEP Reference Data as OWL approach is one step down the road for product data semantics

- » Much more required (and possible) to get full benefits
 - ISO community beginning to participate in ontology community
 - NIST Ontology Summit 2009 is one good example

Part 2: NIST “Future STEP” Project semantics thread



COPYRIGHT EUROSTEP GROUP

NIST

National Institute of Standards and Technology
Technology Administration, U.S. Department of Commerce

NIST “Future STEP” Project Goals

- » To enable enterprise integration based on inter-related data exchange, ontology and service specifications

- » To enable the selective harvesting of ISO 10303 (aka STEP) standards into ontologies and other widespread modeling languages via OMG Model Driven Architecture TM approach
 - ISO TC184 SC4 STEP community has been creating data exchange information models for 20 years – lots of knowledge, lessons learned and capability there

 - With possibility of ISO STEP harvesting improvements made in OMG and W3C back into its standards

 - May lead ISO STEP to adopt OMG & W3C technology

Near-Term Goal - Harvesting STEP

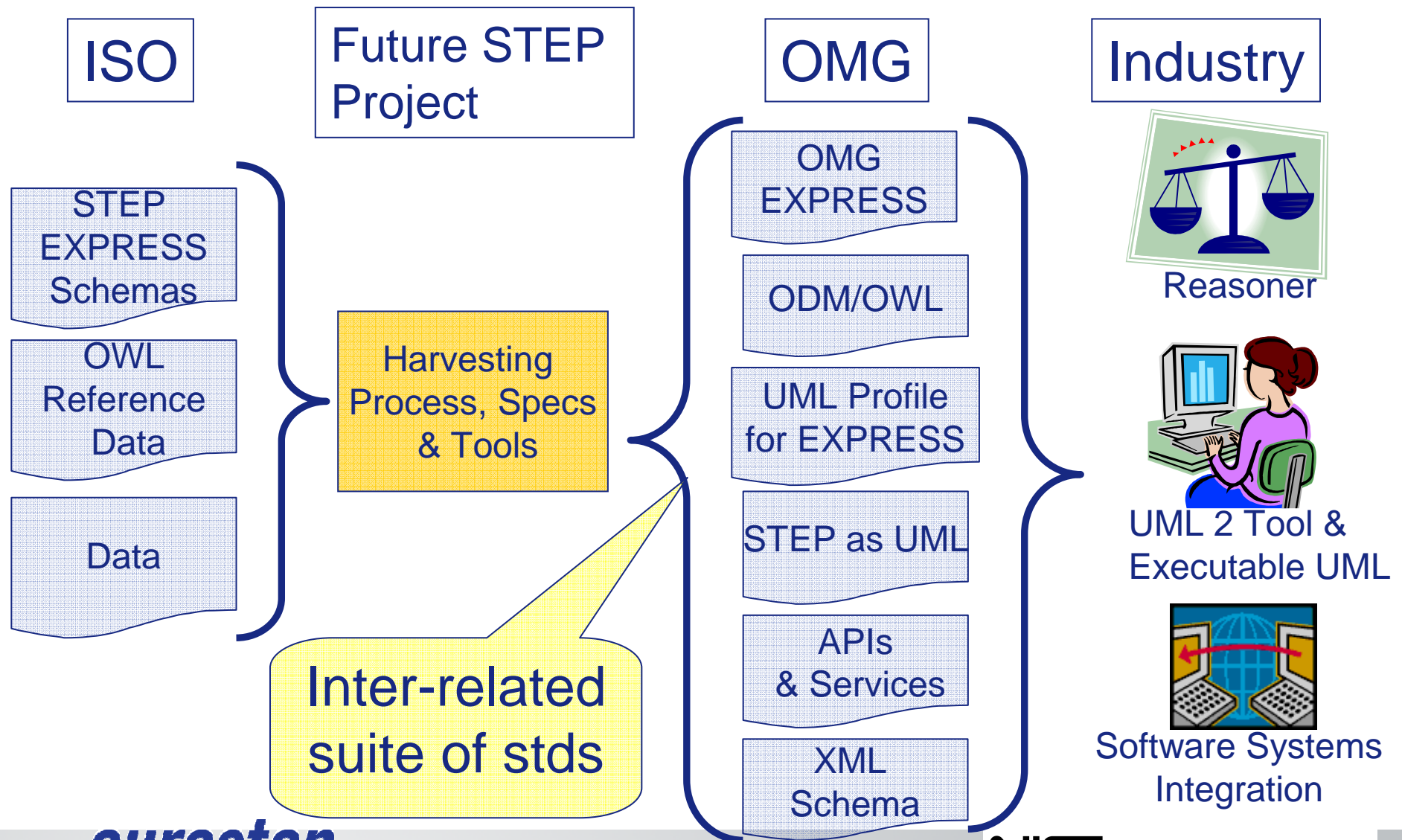

End Goal – New ISO STEP Approach

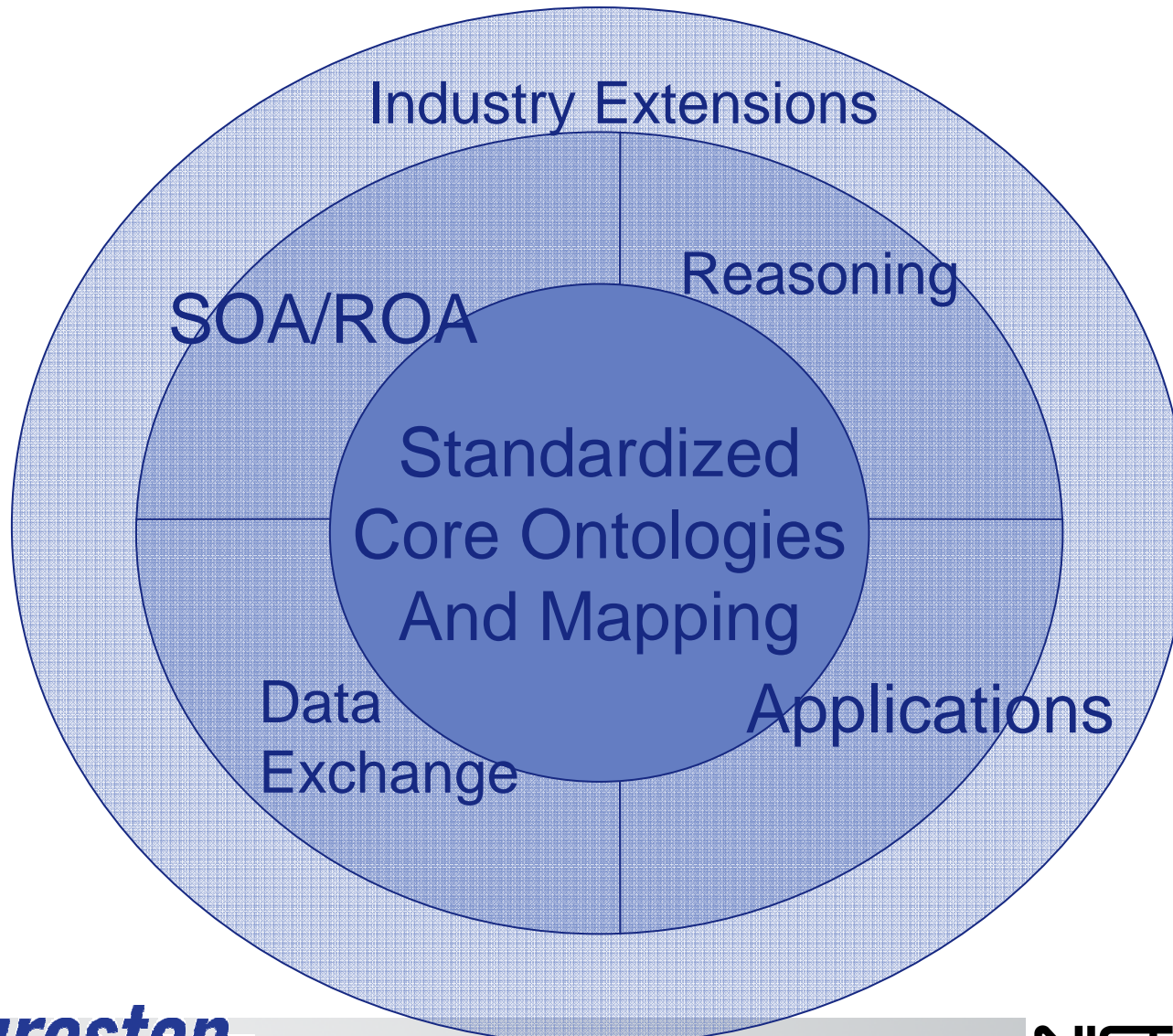

Future STEP Project Semantics Thread

- » Language-related evaluations
 - Meta-model of ISO EXPRESS as OMG standard
 - Formal mapping between EXPRESS and OMG Ontology Definition Metamodel OWL
 - Related using OMG Query/View/Transform (QVT)
- » Inter-related suites of standards
 - Information models for data exchange with OWL Reference Data
 - Ontologies for reasoning
- » Use Systems Engineering domain reference examples
 - » OMG Systems Modeling Language (SysML)
 - » ISO STEP 10303-233 (AP233) Systems Engineering
 - » Example use case : Finding Systems that satisfy Requirements using DL reasoner

Example Use Case

SysML User

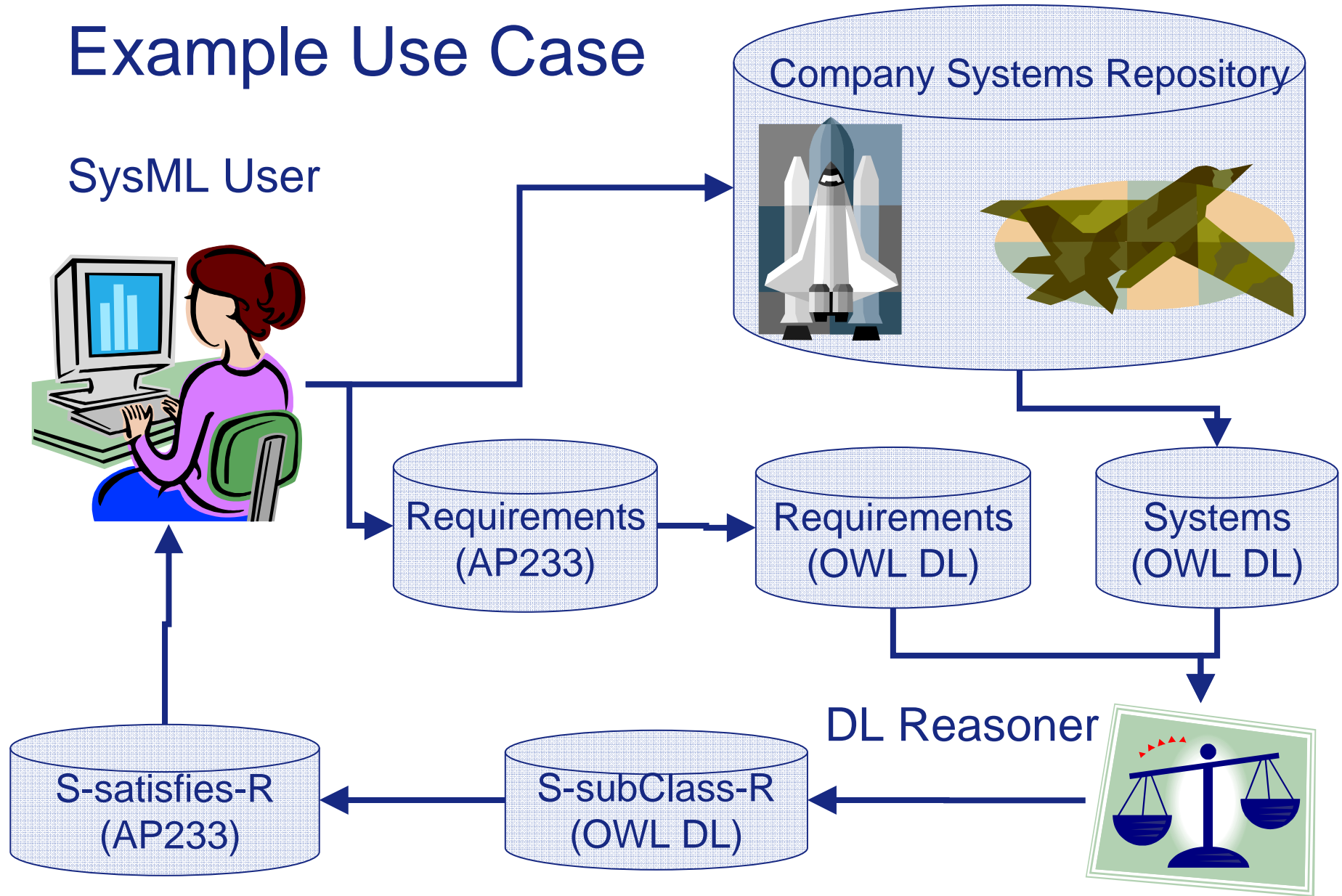

Original Structure Mapping Concepts

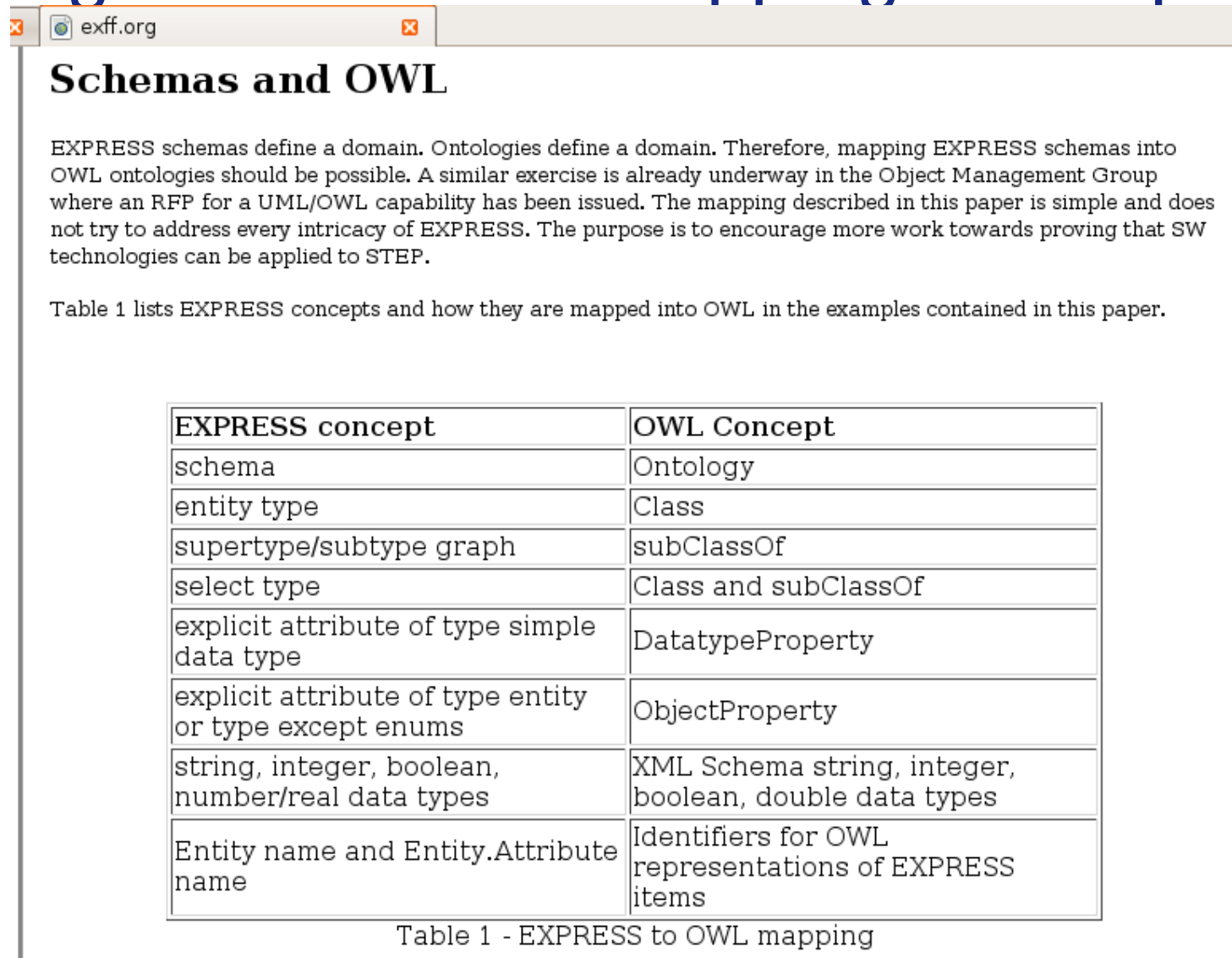

Schemas and OWL

EXPRESS schemas define a domain. Ontologies define a domain. Therefore, mapping EXPRESS schemas into OWL ontologies should be possible. A similar exercise is already underway in the Object Management Group where an RFP for a UML/OWL capability has been issued. The mapping described in this paper is simple and does not try to address every intricacy of EXPRESS. The purpose is to encourage more work towards proving that SW technologies can be applied to STEP.

Table 1 lists EXPRESS concepts and how they are mapped into OWL in the examples contained in this paper.

EXPRESS concept	OWL Concept
schema	Ontology
entity type	Class
supertype/subtype graph	subClassOf
select type	Class and subClassOf
explicit attribute of type simple data type	DatatypeProperty
explicit attribute of type entity or type except enums	ObjectProperty
string, integer, boolean, number/real data types	XML Schema string, integer, boolean, double data types
Entity name and Entity.Attribute name	Identifiers for OWL representations of EXPRESS items

Table 1 - EXPRESS to OWL mapping

Semantic Mapping: Functions Required

- » Assign EXPRESS elements to separate Ontologies regardless of originating EXPRESS Schema
- » Entity Type to Object Property
 - E.g. Organization_assignment
 - Related OWL Reference Data classes map to subPropertyOf
- » Attribute Value to subPropertyOf
 - e.g. Organization_assignment.role value is subPropertyOf OrganizationAssignment
- » Ignore Entity Type, Attribute
- » Assign Attribute Domain, Range, Cardinality
- » Entity Type isMemberOf Entity Type (caveat = OWL Full)
 - e.g. Organization isMemberOf Organization_type

Conclusions

- » Near term approach ready, now for the hard part ... actually doing it
 - Finding QVT tools to specify mappings is a problem
 - » Turns out we are “the pioneer” in this area
 - Planning
 - » June 2009 – publish working drafts for review
 - » September 2009 – deliver specifications and demonstration
 - EXPRESS to ODM OWL mapping as QVT may be RFC to ODM spec
- » End Goal
 - May 2009 presentation of recommendations to ISO STEP community – we hope that starts the process
 - » Note - ISO 15926 4-Dimensionalist ontology standard comes from the same ISO organization
 - NIST Ontology Summit 2009 has been a forcing function to gather momentum/focus

How NIST Ontology Summit 2009 Can Help

- » Add to focus on core ontologies for product (i.e. engineering) data
 - Some basics are required (e.g. Units)

- » Provide guidance on best-practices, and what is “doable” with respect to our goal of harmonized/aligned OWL, UML, EXPRESS, XML Schema, SOA, ROA, etc. For example:
 - Does using Semantic Web Service technology make alignment with OWL any easier?
 - Best practices for
 - » ontology “versioning”, publishing
 - » harmonizing, reusing, subsetting ontologies
 - » **isPartOf** for physical objects vs. for assemblies as designs vs. for SysML/UML composite structure and composite aggregation
 - » Reifying relationships vs. Named graphs?

- » Support overall objectives in communiqué