

Prolog, Rules,
Reasoning
and
SPARQLing Magic
in the real world

Contents

- How do we fit it all together: rules and prolog and reasoning and magic predicates and SPARQL
- Use case: BigBank
 - Event view of the world
 - Using Social Network Analysis, Geo and Temporal reasoning (embedded in Prolog and SPARQL 1.1)
 - Fraud detection

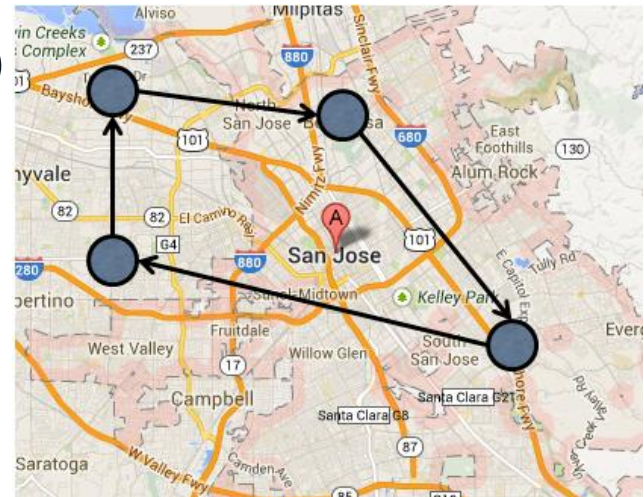

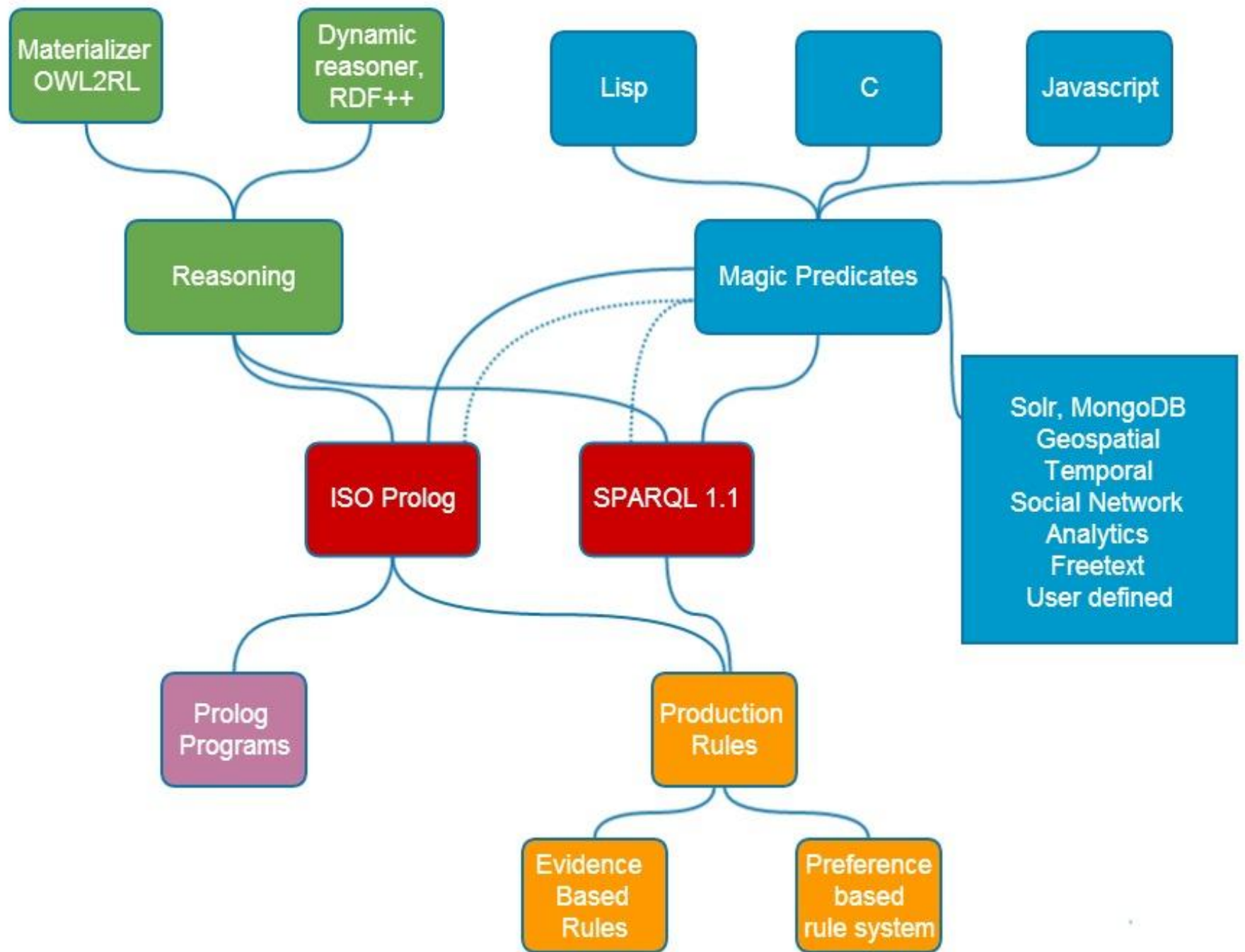

Reasoning

- For Static data sets we recommend the Materializer
 - OWL2RL, make it as complex as you want
- For dynamic applications we recommend the dynamic, RDFS++ reasoner
 - Mostly good for class hierarchies
 - Don't go overboard with sub property chains
 - Keep your transitive relations simple
 - Avoid sameas if you can
 - Avoid inverse if you are in control of your application
- You can turn it on or off
- Both SPARQL and Prolog can use it.

Both Prolog and SPARQL can use the reasoner

```
with reasoning OFF

(select ?type (q !fr:Jans !rdf:type ?type))

select ?type {q fr:Jans a ?type }

{Human}

with reasoning ON

{Human}
{Mammal}
{Animal}
{Thing}□
```

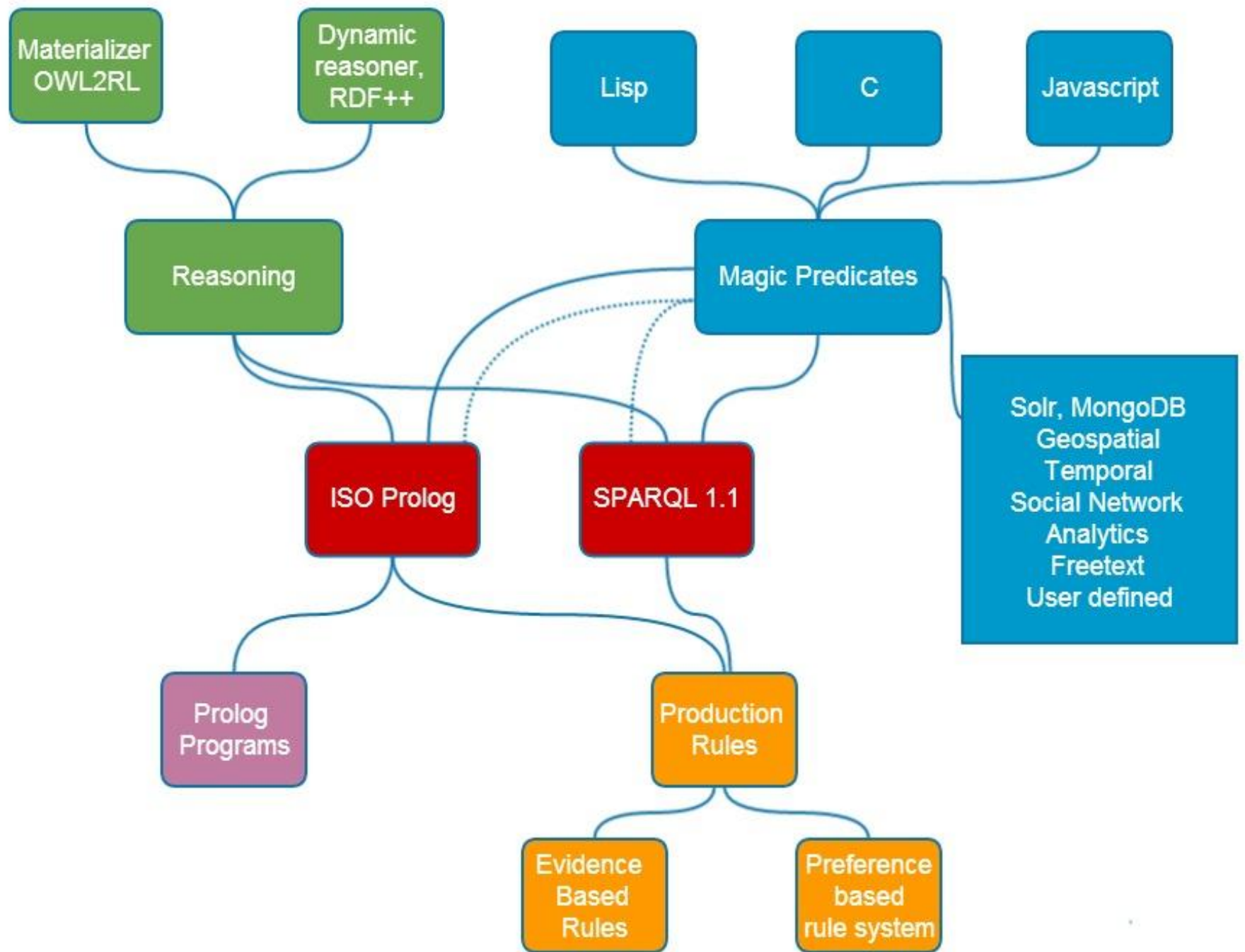

Magic Properties

- Predicates as functions (instead of real triples)
- Here is a SPARQL query with three magic properties from the Social Network Analysis Library

centrality

Query language: Query planner: Result limit:

```
1 prefix sna: <http://franz.com/ns/allegrograph/4.11/sna/>
2 select ?email ?centrality {
3   ?who bb:email 'Sonia.Madrid@gmail.com' .
4   ?group sna:egoGroup ( bb:paid ?who 3 ) .
5   (?member ?centrality) sna:actorDegreeCentrality (bb:paid ?group) .
6   FILTER(?member != ?who)
7   ?member bb:email ?email
8 } order by desc(?centrality)
9 limit 10|
```

Execute

Save

as centrality

Add to repository

Result

Download as

email

centrality

SPARQL Magic Properties

Table of Contents

Introduction

Freetext

Geospatial

Magic properties

Helper Functions

SNA

Generators

Neighbors

Groups and Centrality Measures

Neighbor Caches

Paths

Cliques

Temporal

relations between points

relation between intervals

relations between points and intervals

relations between points and datetimes

relations between intervals and datetimes

Implementation Notes

Property places that must be bound

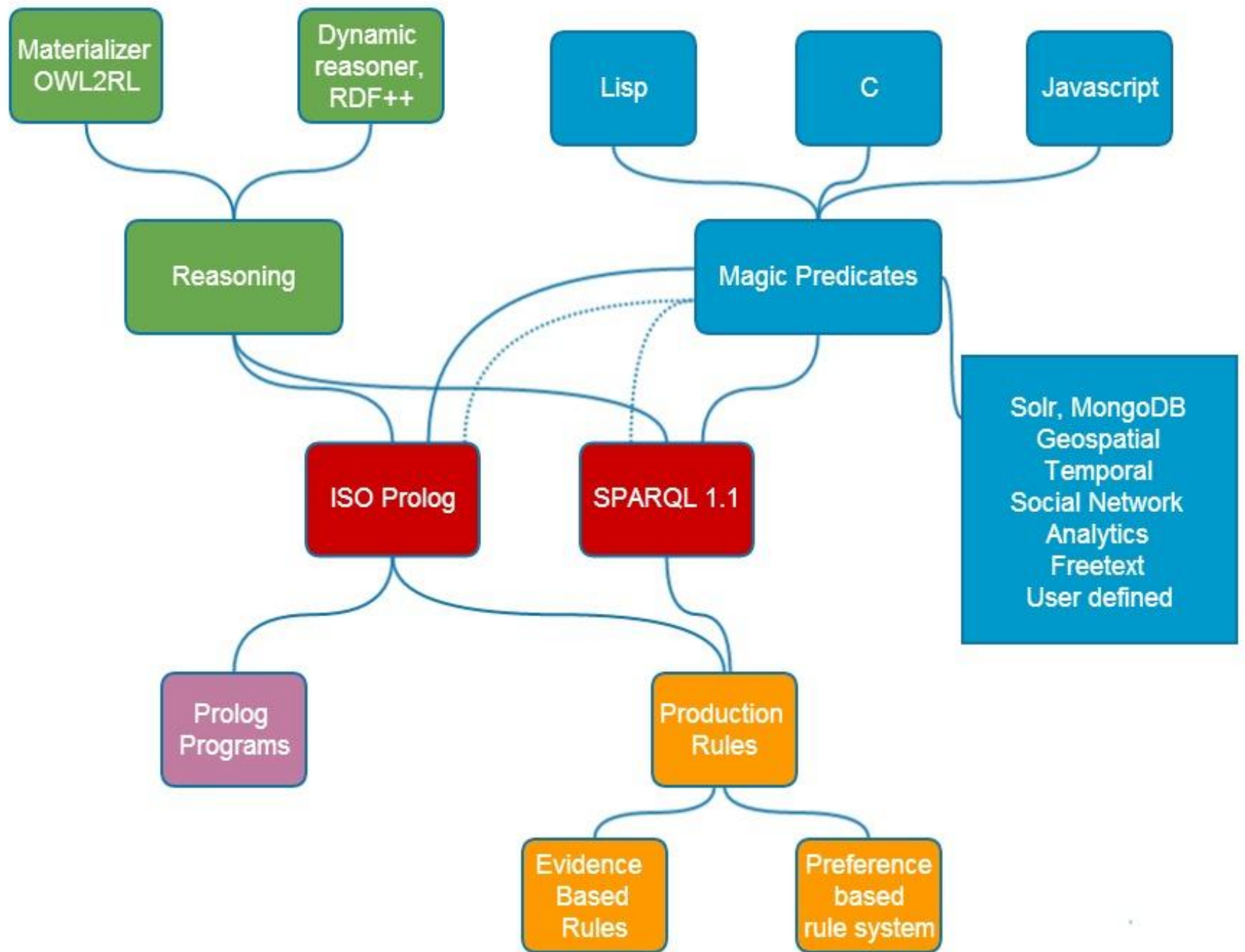

Prolog

- ISO Standard
- A full Query and **Programming Language**
 - Where SPARQL is only an **access language**
- How do customers use it:
 - Create libraries and domain specific languages
 - Build up hierarchies of functors
- So that the final queries and rules are simpler to read and maintain.

A silly example of building up hierarchy of functors

```
(<-- (male ?x) (q ?x !o:sex !o:male))
(<-- (female ?x) (q ?x !o:sex !o:female))

(<-- (father ?x ?y)
     (male ?x)
     (q ?x !o:has-child ?y))

(<-- (mother ?x ?y)
     (female ?x)
     (q ?x !o:has-child ?y))

(<-- (parent ?x ?y)
     (or (father ?x ?y)
         (mother ?x ?y)))

(<-- (ancestor ?x ?y)
     (parent ?x ?y))

(<- (ancestor ?x ?y)
     (parent ?x ?z)
     (ancestor ?z ?y))
```

Real World Example..

```
;; Rule 6
```

```
(defrule poi-has-partner-through-closeness (poi)
  (select ()
    (most-recent-event (?? poi) ?event)
    (q ?event !f:location ?loc)
    (nearby ?other-event ?loc !f:location 3)
    (not (= ?event ?other-event))
    (most-recent-event-p ?other-event)
    (q ?other-event !f:actor ?poi2)
    (suggest (?? poi) 1)))
```

```
;; Rule 7
```

```
(defrule closeness-from-poi-to-target (poi)
  (select ()
    (most-recent-event (?? poi) ?event1)
    (member ?target (?? *targets*))
    (most-recent-event ?target ?event2)
    (distance-between-events ?event1 ?event2 ?dist)
    (lisp ?value (if* (< ?dist 1) then 10
                     elseif (< ?dist 2) then 5
                     elseif (< ?dist 3) then 4
                     elseif (< ?dist 10) then 1 else 0))
    (suggest (?? poi) ?value)))
```

■

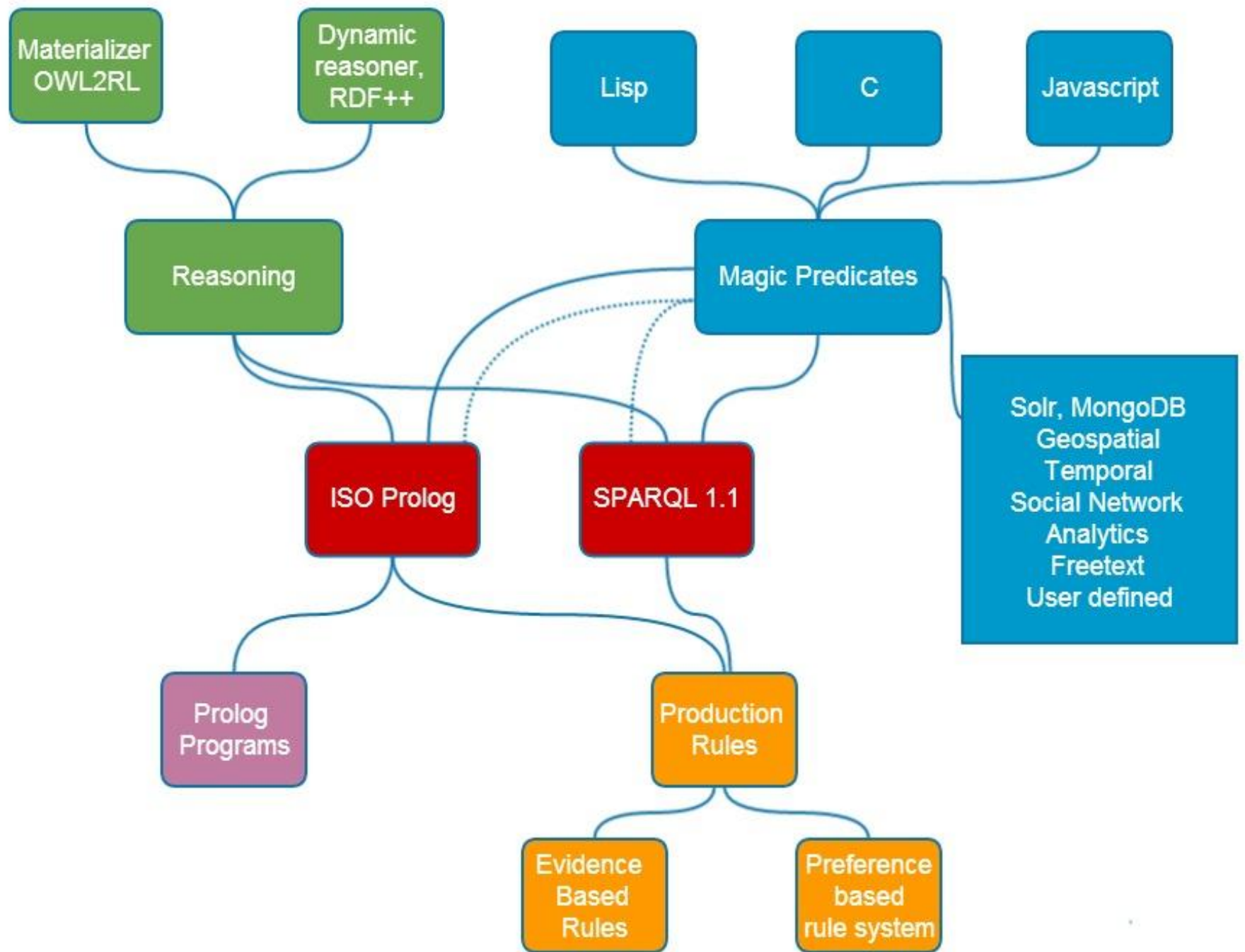

Production Rules

- Can be written in Prolog or Sparql
- Evidence based rule systems
 - Applied in a complex event handling situation
 - Apply 100's of rules after every few seconds or after X new events
 - Add or subtract points from hypotheses, or the danger level of an entity or the threat level of a potential target.
- Also mix with our Bayesian Belief Network interface to Netica

Real World Example..

```
;; Rule 6
```

```
(defrule poi-has-partner-through-closeness (poi)
  (select ()
    (most-recent-event (?? poi) ?event)
    (q ?event !f:location ?loc)
    (nearby ?other-event ?loc !f:location 3)
    (not (= ?event ?other-event))
    (most-recent-event-p ?other-event)
    (q ?other-event !f:actor ?poi2)
    (suggest (?? poi) 1)))
```

```
;; Rule 7
```

```
(defrule closeness-from-poi-to-target (poi)
  (select ()
    (most-recent-event (?? poi) ?event1)
    (member ?target (?? *targets*))
    (most-recent-event ?target ?event2)
    (distance-between-events ?event1 ?event2 ?dist)
    (lisp ?value (if* (< ?dist 1) then 10
                     elseif (< ?dist 2) then 5
                     elseif (< ?dist 3) then 4
                     elseif (< ?dist 10) then 1 else 0))
    (suggest (?? poi) ?value)))
```

■

A Big Asian Bank: find fraud

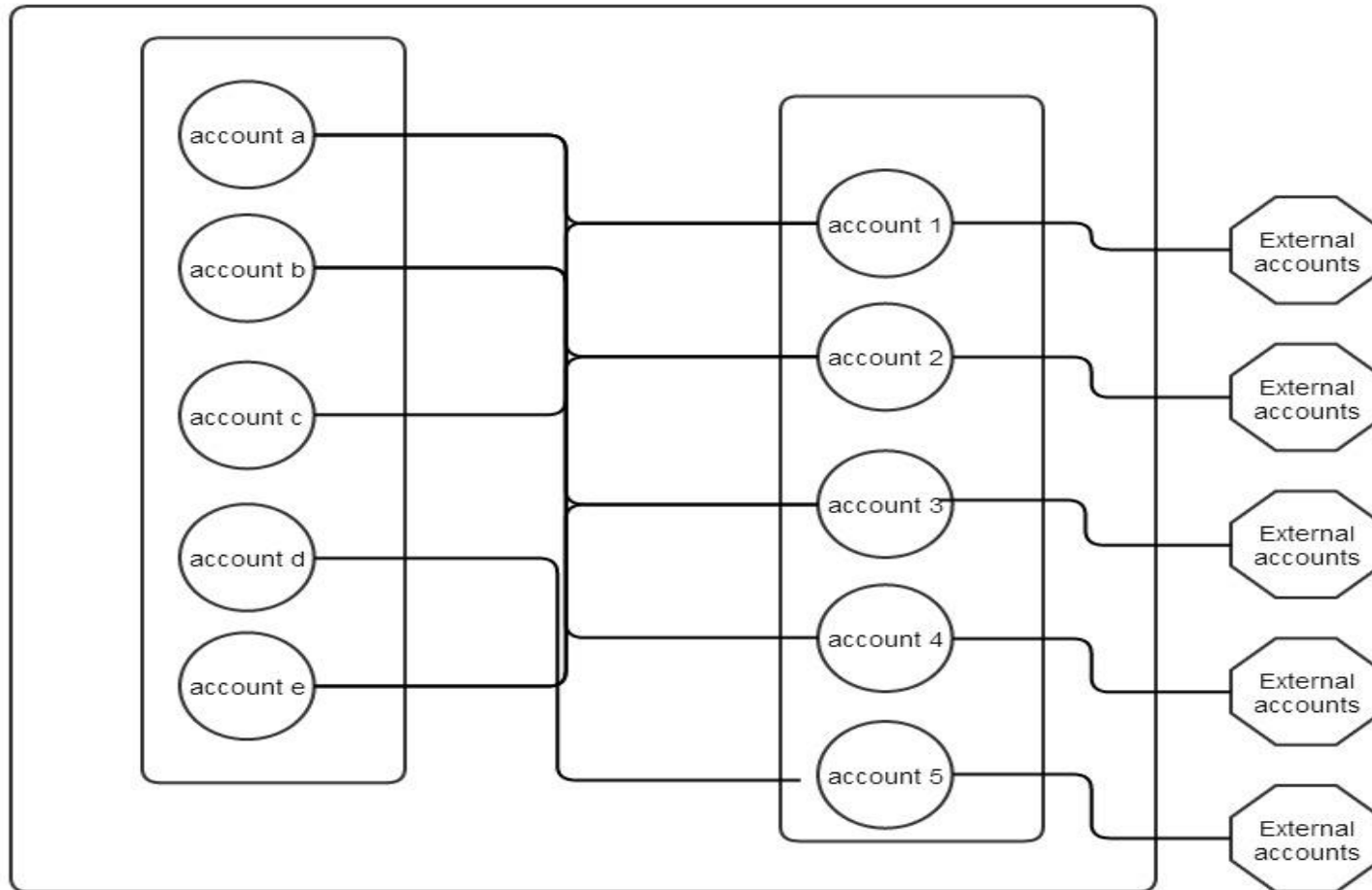

A Big Asian Bank: find fraud

1. > 5 accounts opened in 1 hour

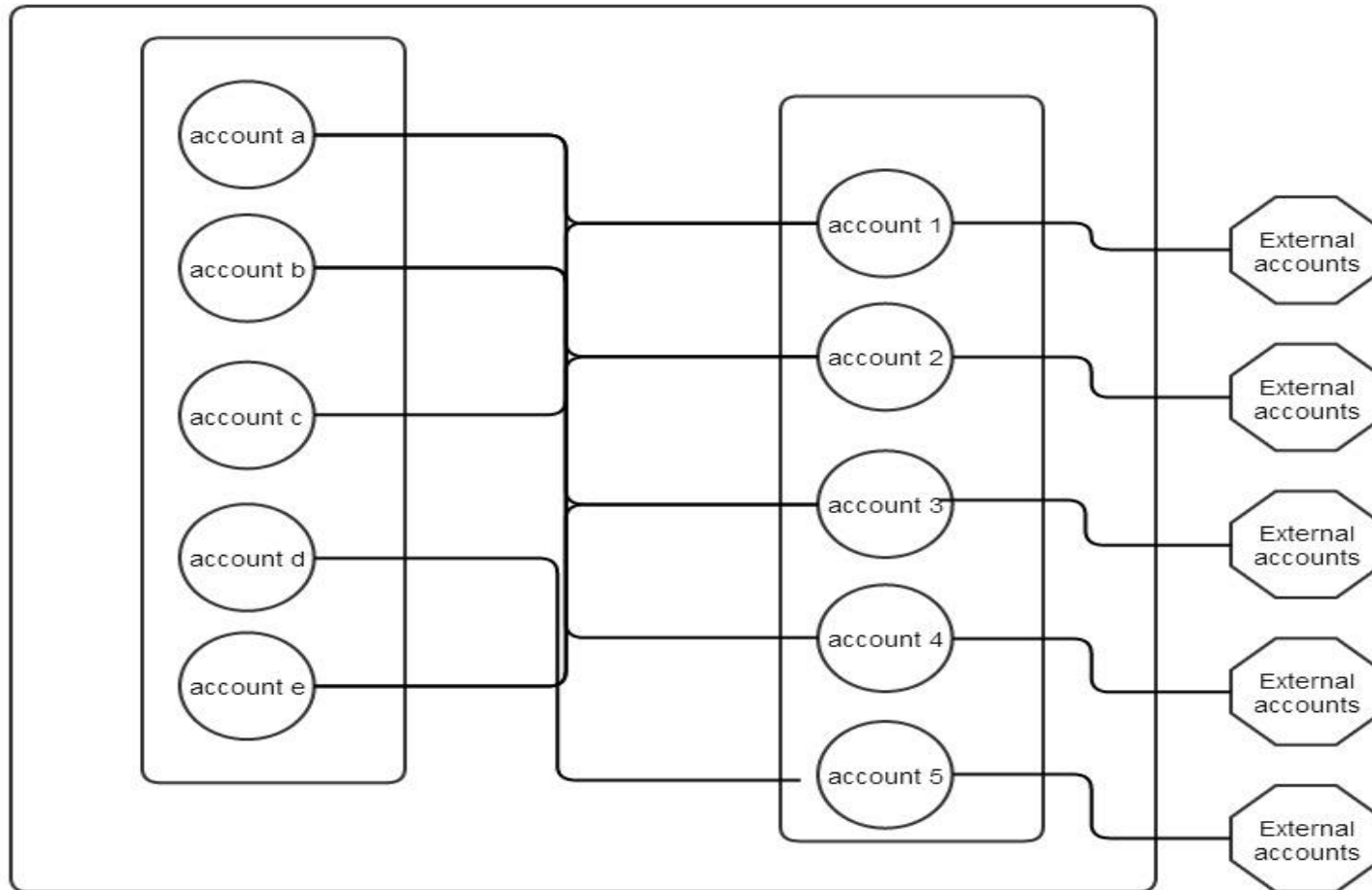

A Big Asian Bank: find fraud

1. > 5 accounts opened in 1 hour

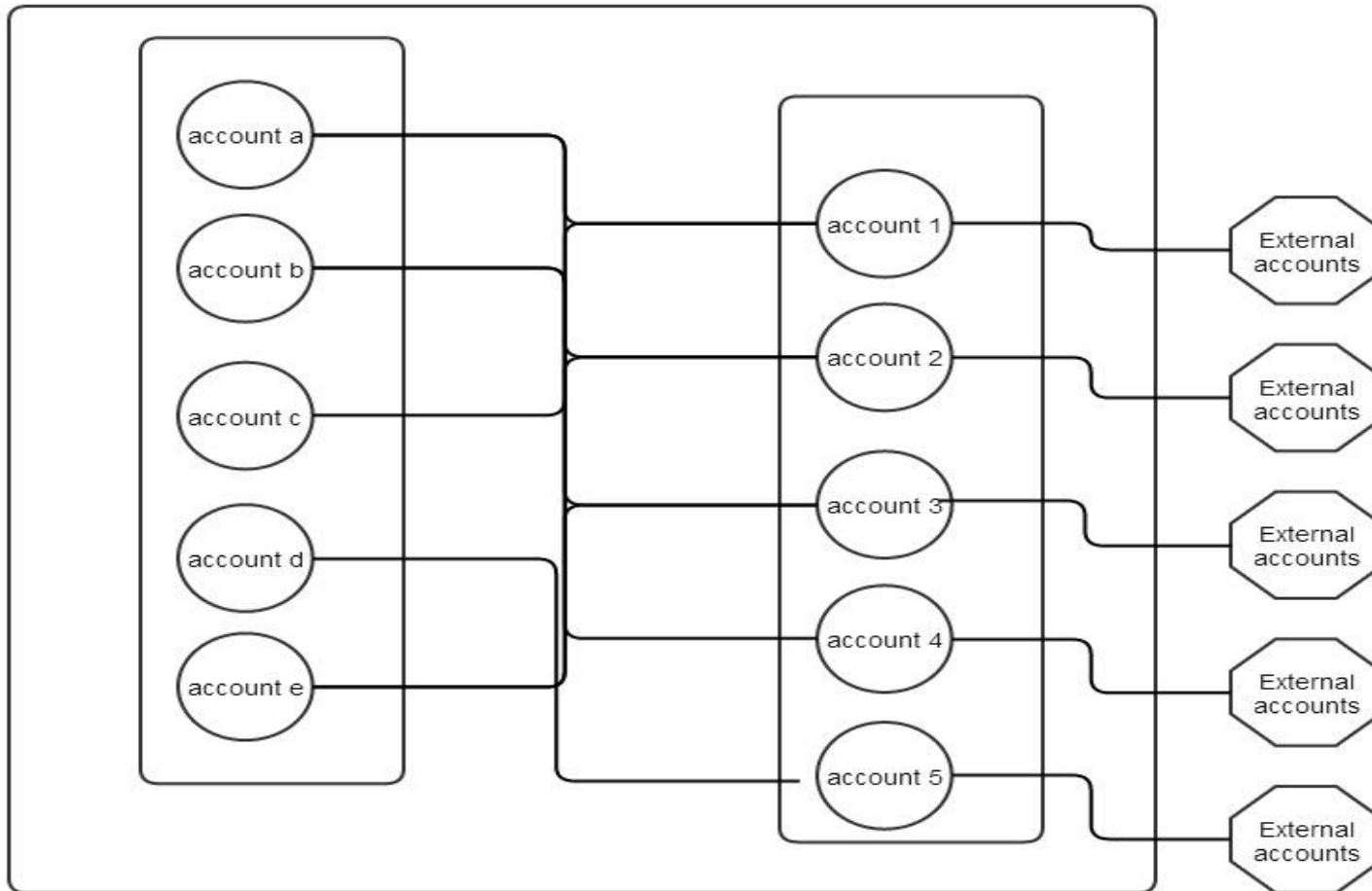

2. Within 30 minutes other accounts pay large money into new accounts

A Big Asian Bank: find fraud

1. > 5 accounts opened in 1 hour

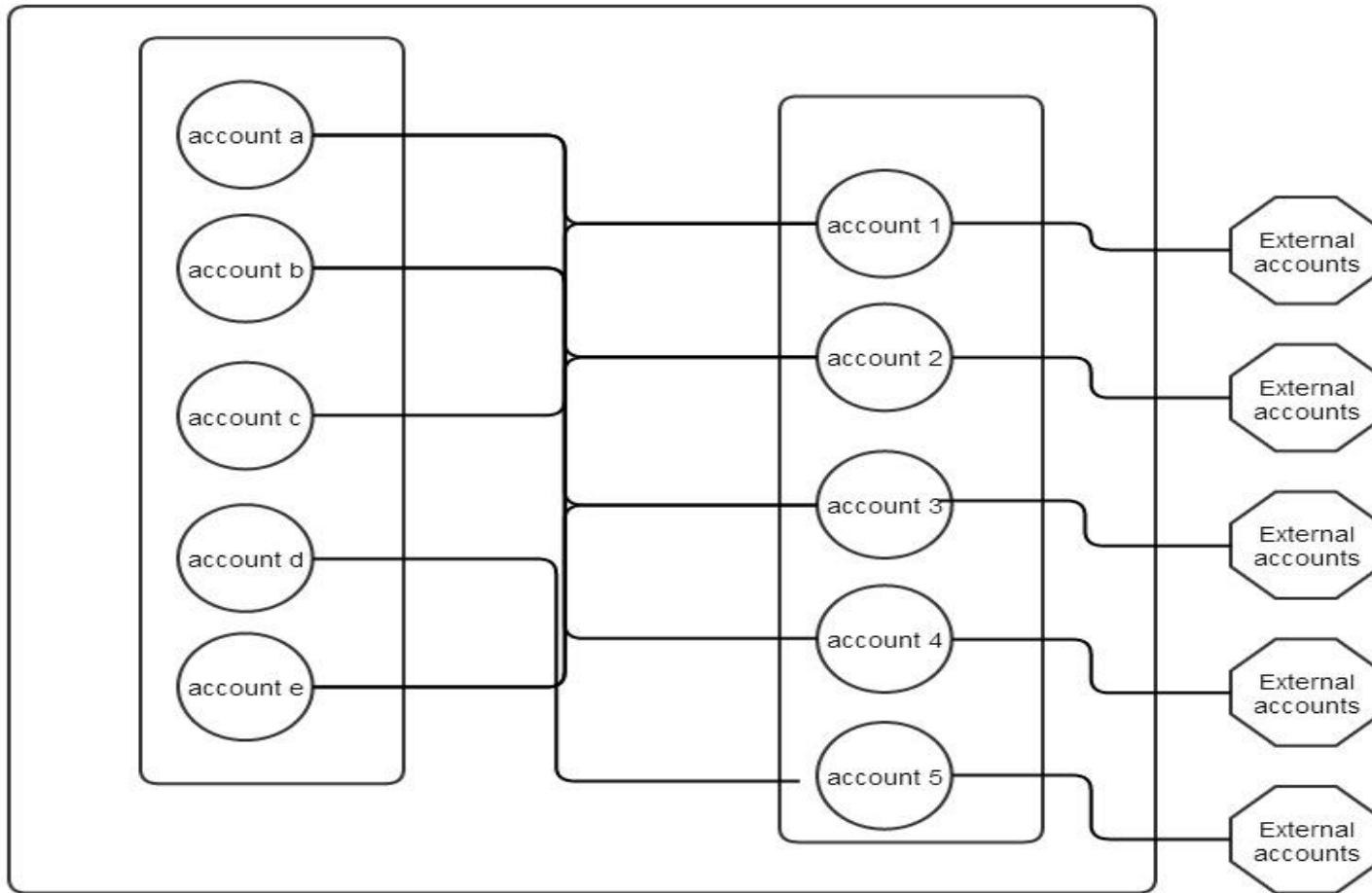

2. Within 30 minutes other accounts pay large money into new accounts

3. In the next hour money flows into external accounts and credit cards

A Big Asian Bank: find fraud

1. > 5 accounts opened in 1 hour

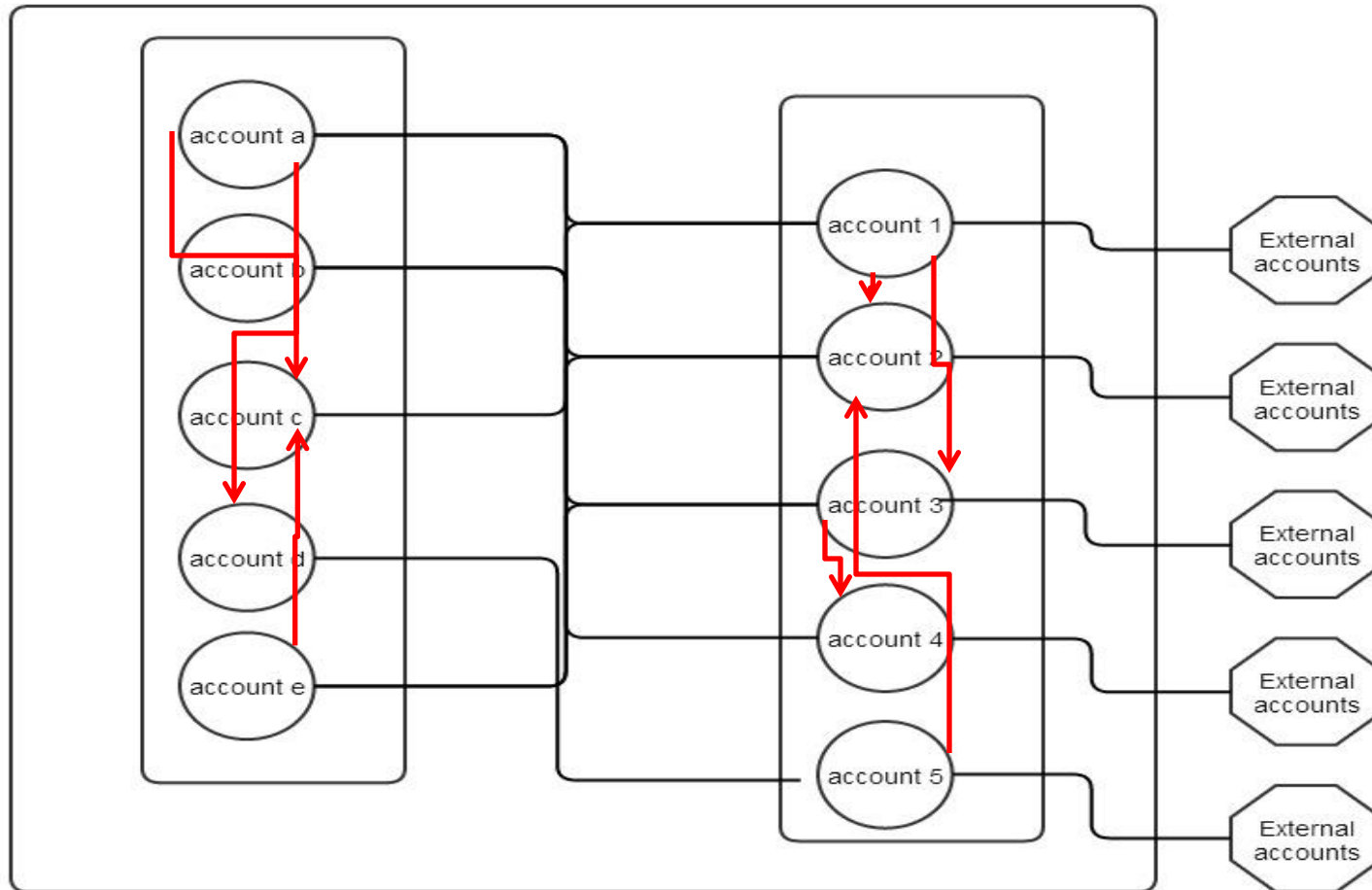

2. Within 30 minutes other accounts pay large money into new accounts

4. Evidence that accounts are Somehow related

3. In the next hour money flows Into external accounts and credit cards

A very simple event ontology

A type

Meetings, communications event, financial transactions, visits, attack/truce, insurance claims, purchase orders

RDFS++ reasoning

A list of actors

Social Network Analysis

A place

GeoSpatial Reasoning

A Start-time and possible an end-time

Temporal Reasoning

Anything else that describes the event

Events are everywhere

- Communication events
 - Telephone, SMS, Email
- Social media
 - Tweets: sender, receiver, topics about people..
- Payments
 - Online, credit card,
- Insurance
 - Claims, payments
- E-commerce
 - Purchase orders
 - Website visits

For our analysis we use

- Social Network Analysis and Graph Analytics
- Temporal reasoning
- Geospatial reasoning

Embedded in Prolog and SPARQL 1.1

Social Network Analysis answers 4 questions

How far is P1 from P2
and how strong is the relation

To what groups does this person
belong (ego groups, cliques?)

How important is this
person in the group?

Does this group have
a leader, how cohesive
are they?

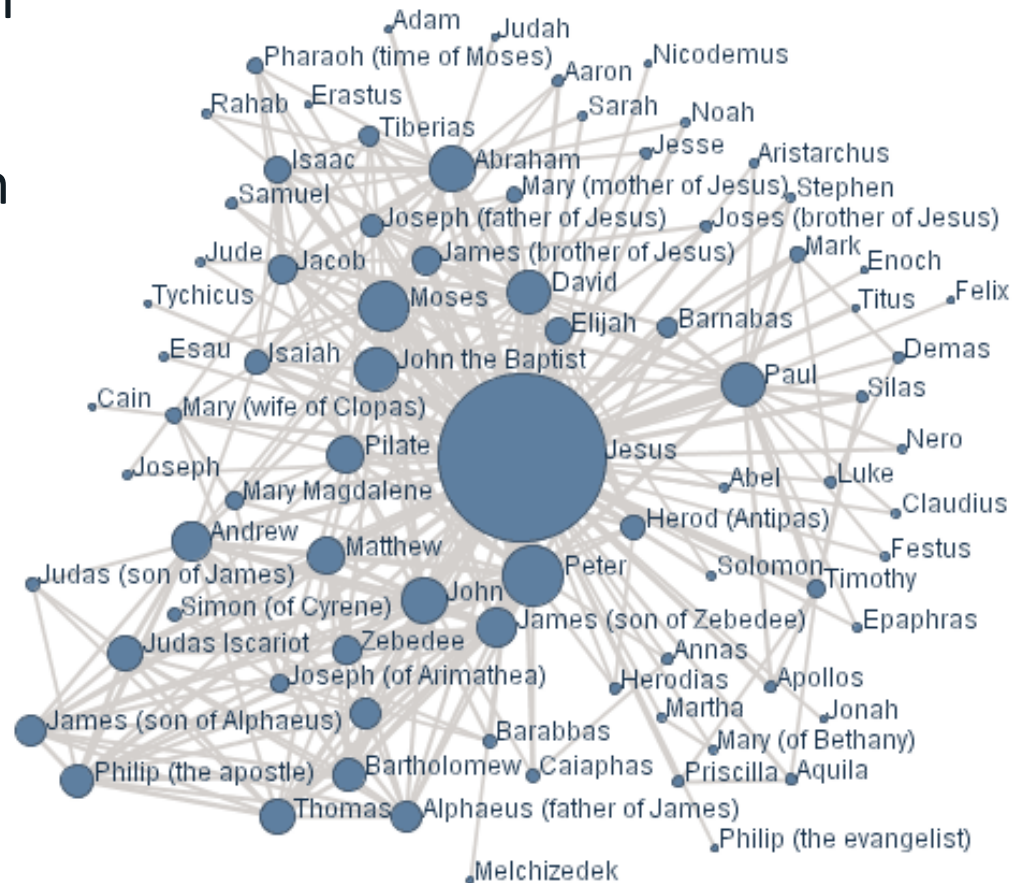

Geospatial Reasoning



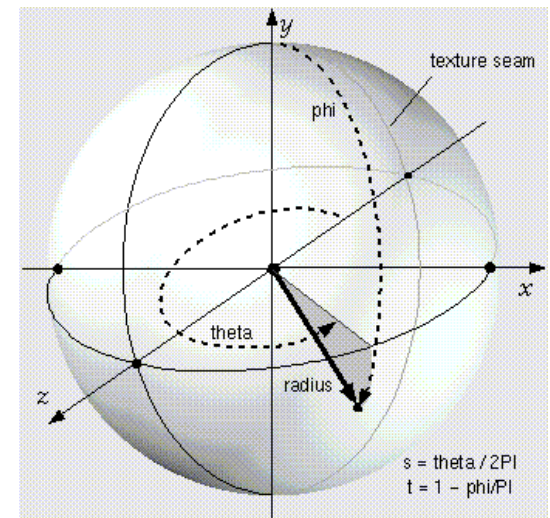
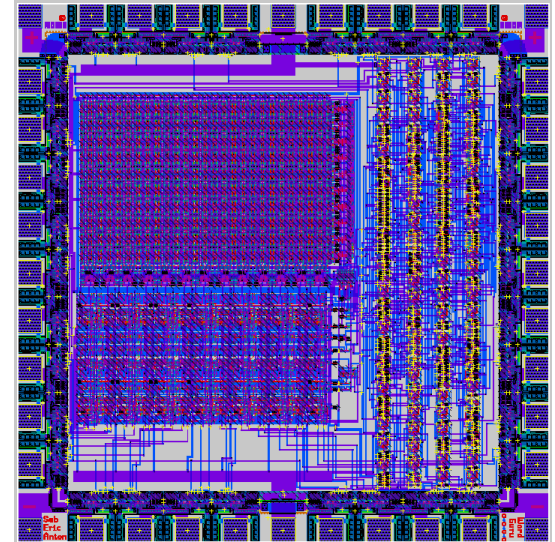





- Make the following super efficient
 - Where did something happen?
 - How far was event1 from event2?
 - Find all the events that occurred in a bounding box or radius of M miles?
 - Do these two shapes overlap?
 - Find all the objects in the intersection of two shapes
- On a very large scale
 - when things don't fit in memory
 - millions of events and polygons

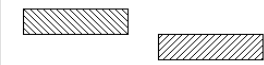
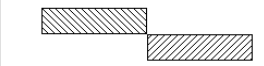
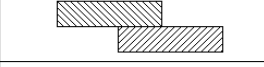

Temporal Reasoning

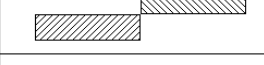
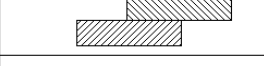
Adhere to our convention
to encode StartTimes and
EndTimes and enjoy
efficient temporal
primitives

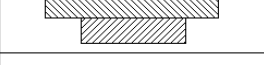
Implementation of
Allen's interval
logic primitives

	<code>(interval-before ?e1 ?e2)</code>
	<code>(interval-meets ?e1 ?e2)</code>
	<code>(interval-overlaps ?e1 ?e2)</code>
	<code>(interval-starts ?e1 ?e2)</code>
	<code>(interval-during ?e1 ?e2)</code>
	<code>(interval-finishes ?e1 ?e2)</code>
	<code>(interval-after ?e1 ?e2)</code>
	<code>(interval-met-by ?e1 ?e2)</code>
	<code>(interval-overlapped-by ?e1 ?e2)</code>
	<code>(interval-started-by ?e1 ?e2)</code>
	<code>(interval-contains ?e1 ?e2)</code>
	<code>(interval-finished-by ?e1 ?e2)</code>
	<code>(interval-cotemporal ?e1 ?e2)</code>

Activity recognition

Find all meetings that happened in December within 5 miles of Berkeley that was attended by the most important person in Jans' friends and friends of friends.

```
(select (?x)
  (ego-group person:jans knows ?group 2)
  (actor-centrality-members ?group knows ?x ?num)
  (q ?event fr:actor ?x)
  (qs ?event rdf:type fr:Meeting)
  (interval-during ?event "2013-12-01" "2013-12-18")
  (geo-box-around geoname:Berkeley ?event 5 miles)
!)
```

SNA
SNA
DB Lookup
RDFS
Temporal
Spatial

Back to the Fraud example

Accounts

Opened at some time, at an IP address, with email, in a particular location.

Events

Payments between accounts from some IP address, at some location at some time. Sender, receivers, amounts

Locations with latitudes and longitudes

Bruce.Rosie@hitachi.com

Revisit



Show All Triples

Property	Value	
Account Date Time UT	3256525427	
Account IP	1.323.225.6	
Account Number	6673190296	
Account Place	Gun Barrel City	
Email	Bruce.Rosie@hitachi.com	
Label	Bruce.Rosie@hitachi.com	
Paid	Ursula.Bouillion@franz.com	00005976
	Ursula.Bouillion@franz.com	00005979
	Ginny.Blick@easychair.org	00005973
	Tracey.Spight@gmail.com	00005975
	Curt.Gallaher@franz.com	00005978
	Clarence.Baran@franz.com	00005977
	Kathryn.Klapp@gmail.com	00005974
Paid-medium	Ursula.Bouillion@franz.com	00005976
	Ursula.Bouillion@franz.com	00005979
Paid-medium-large	Curt.Gallaher@franz.com	00005978
	Clarence.Baran@franz.com	00005977
Paid-normal	Kathryn.Klapp@gmail.com	00005974
Paid-small	Ginny.Blick@easychair.org	00005973
Paid-very-small	Tracey.Spight@gmail.com	00005975
Time	2003-03-13T06:23:47Z	
Type	Buyer	
is Paid of	Jeremy.Whitesides@franz.com	00004501
	Kathryn.Errico@wellsfargo.com'	00004831
	Angel.Readnour@vulcan.com	00004479
	Dave.Eichhorn@sgi.com	00003315
	Nellie.Hahn@reply.facebook.com	00003252
is Paid-large of	Angel.Readnour@vulcan.com	00004479
is Paid-medium of	Kathryn.Errico@wellsfargo.com'	00004831
is Paid-medium-small of	Jeremy.Whitesides@franz.com	00004501
is Paid-normal of	Dave.Eichhorn@sgi.com	00003315
is Paid-very-small of	Nellie.Hahn@reply.facebook.com	00003252

Gun Barrel City

Revisit



Show All Triples

Property	Value	
Left-click a property to collapse or expand its rows. Shift-left-click to add a property's triples to the graph	Left-click a value to visit it in the table view and add the triple to the graph view. Right-click a value or press M for a menu of navigation commands. J moves down a row, K moves up, and L moves to the other column.	
Admin1 code	TX	
Admin2 code	213	
Alternatenames		
Asciname	Gun Barrel City	
Cc2		
Country code	US	
Elevation	107	
Feature class	P	
Feature code	PPL	
Geonameid	4695535	
Gtopo30	106	
Label	Gun Barrel City	
Latitude	32.33458709716797d0 -96.15135955810547d0	
Lon-lat-5	-96.1513595117845d0 32.33458707912458d0	
Modification date	2006-01-17	
Population	5856	
Timezone	America/Denver	
is Account Place of	Bruce.Rosie@hitachi.com	
is Event Place of	\$13 \$430 \$511 \$106	

\$430

Revisit



Show All Triples

Property

Left-click a property to collapse or expand its rows. Shift-left-click to add a property's triples to the graph

Value

Left-click a value to visit it in the table view and add the triple to the graph view.
Right-click a value or press M for a menu of navigation commands.
J moves down a row, K moves up, and L moves to the other column.

Amount	430
Event Date Time UT	3539822738
Event IP	1.323.225.6
Event Place	Gun Barrel City
Label	\$430
Receiver	Kathryn.Klapp@gmail.com
Sender	Bruce.Rosie@hitachi.com
Time	2012-03-04T04:05:38Z
Type	Normal

Account Place →
Event Place →

Buyer
Normal
No Type

Bruce.Rosie@hitachi.com

Gun Barrel City

\$430

Current Predicates

- Event IP
- Event Place
- Feature class
- Feature code
- Geonameid
- Gtopo30
- Label
- Latitude
- Lon-lat-5
- Modification date
- Paid
- Paid-large
- Paid-medium
- Paid-medium-large
- Paid-medium-small
- Paid-normal
- Paid-small
- Paid-very-small
- Population
- Receiver
- Sender
- Time
- Timezone
- Type

Receiver, Sender

Select All Deselect All

OK Cancel



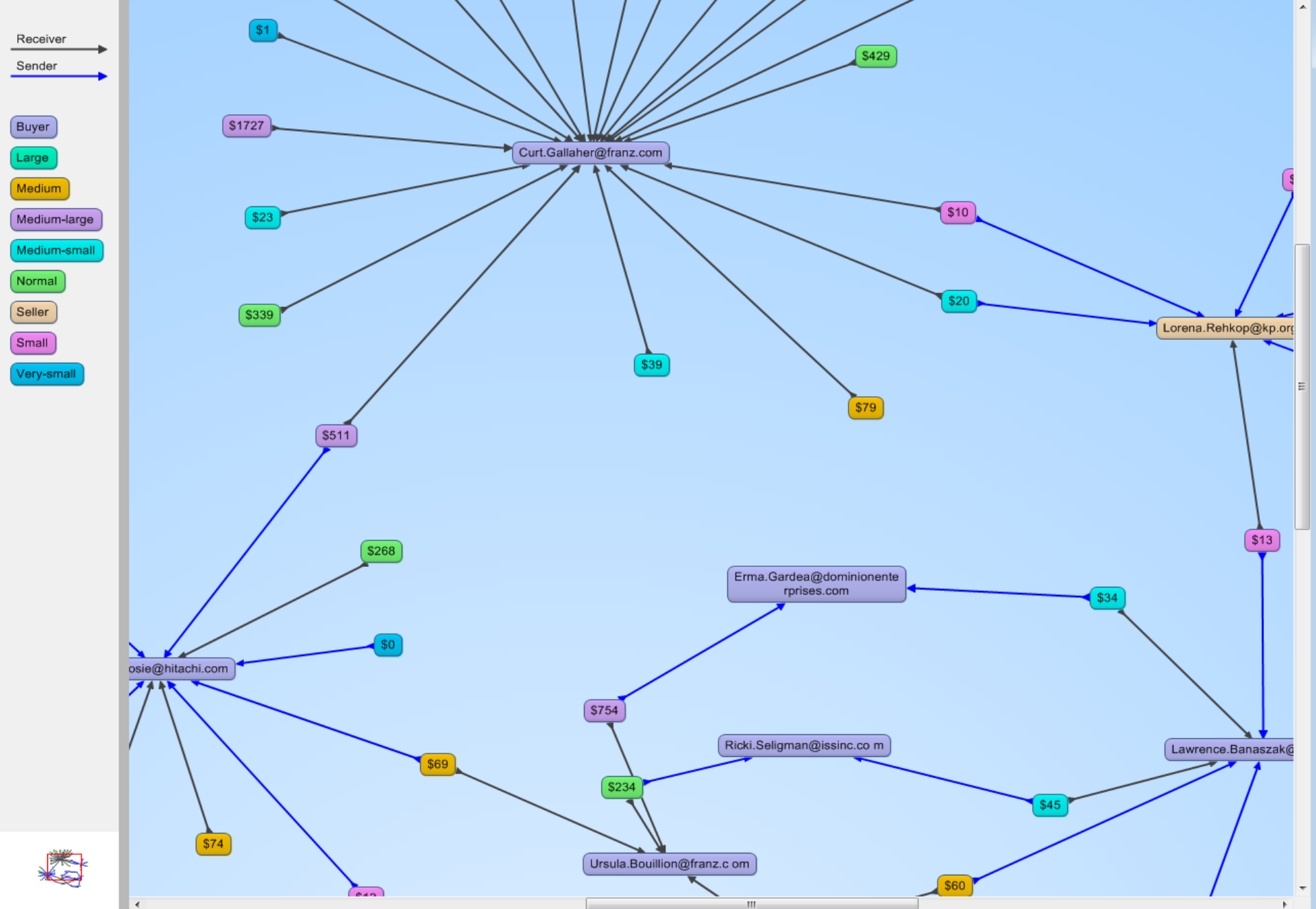

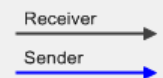

- Buyer
- Large
- Medium
- Medium-large
- Medium-small
- Normal
- Seller
- Small
- Very-small

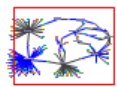
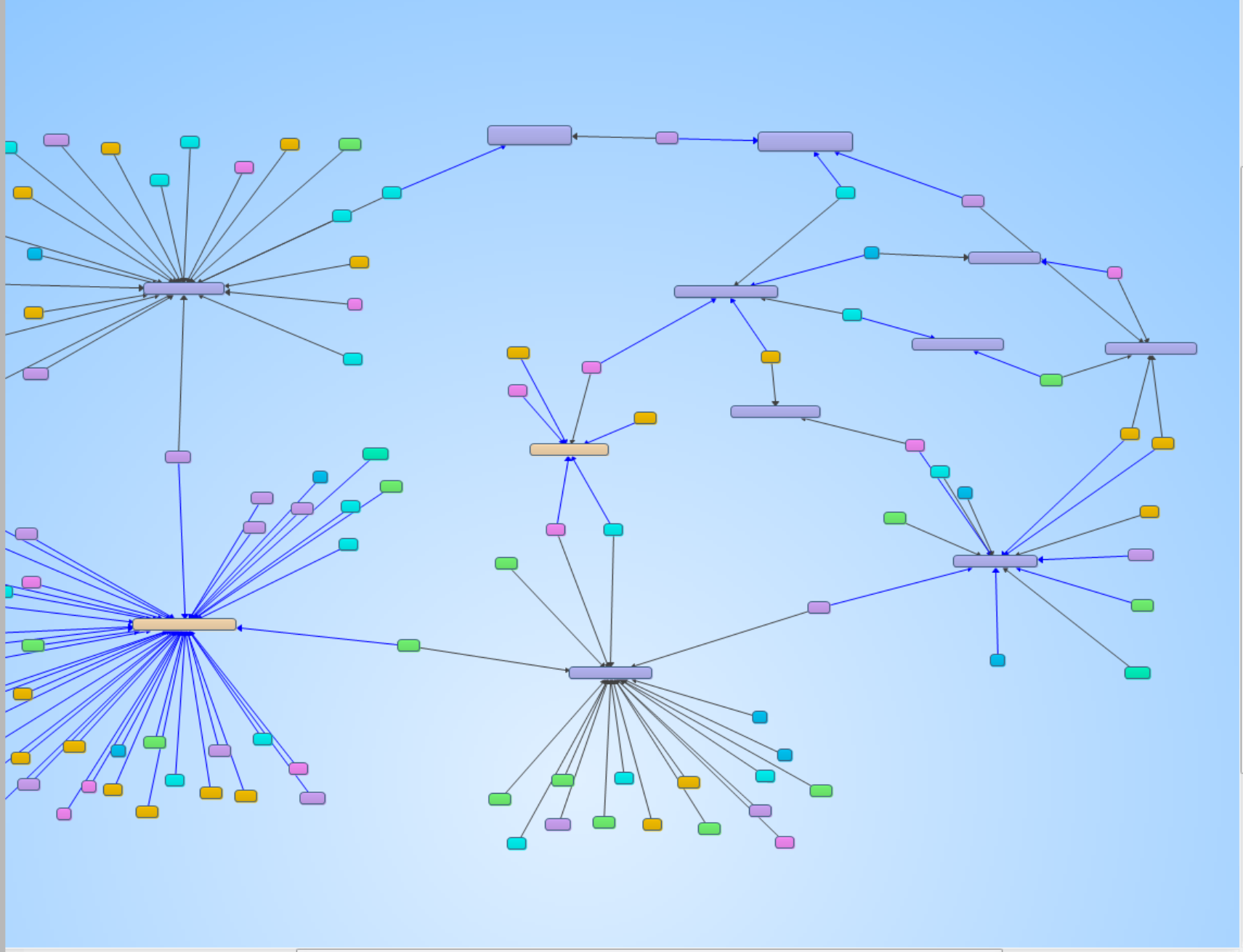

Edit query

Query language: Query planner: Result limit: [show](#)

```
1 # Did the most important friends of Sonia make a payment
2 # within 100 miles of Rotterdam (NY)
3 # in the last 10 years?
4 prefix sna: <http://franz.com/ns/allegrograph/4.11/sna/>
5 select ?email ?centrality ?amount {
6   ?place rdfs:label 'Rotterdam' ; gn:admin1_code 'NY' ; gn:lon-lat-5 ?location
7
8   ?who bb:email 'Sonia.Madrid@gmail.com' .
9   ?group sna:egoGroup ( bb:paid ?who 2 ) .
10  (?member ?centrality) sna:actorDegreeCentrality (bb:paid ?group) .
11  FILTER(?member != ?who)
12  # filter (?centrality > 0.1)
13  ?event bb:sender ?member ; franzTime:time ?time ; bb:amount ?amount ; franz:
14  filter( ?time >= '2002-01-01'^^xsd:dateTime && ?time <= '2013-01-01'^^xsd:da
15  ?member bb:email ?email .
16  ?otherPlace franzGeo:inCircleMiles (gn:lon-lat-5 ?location 100) .
17  ?otherPlace rdfs:label ?otherPlaceName .
18 } order by desc(?centrality)
19
20
```

 as

Analysts have a chance of reading and writing this

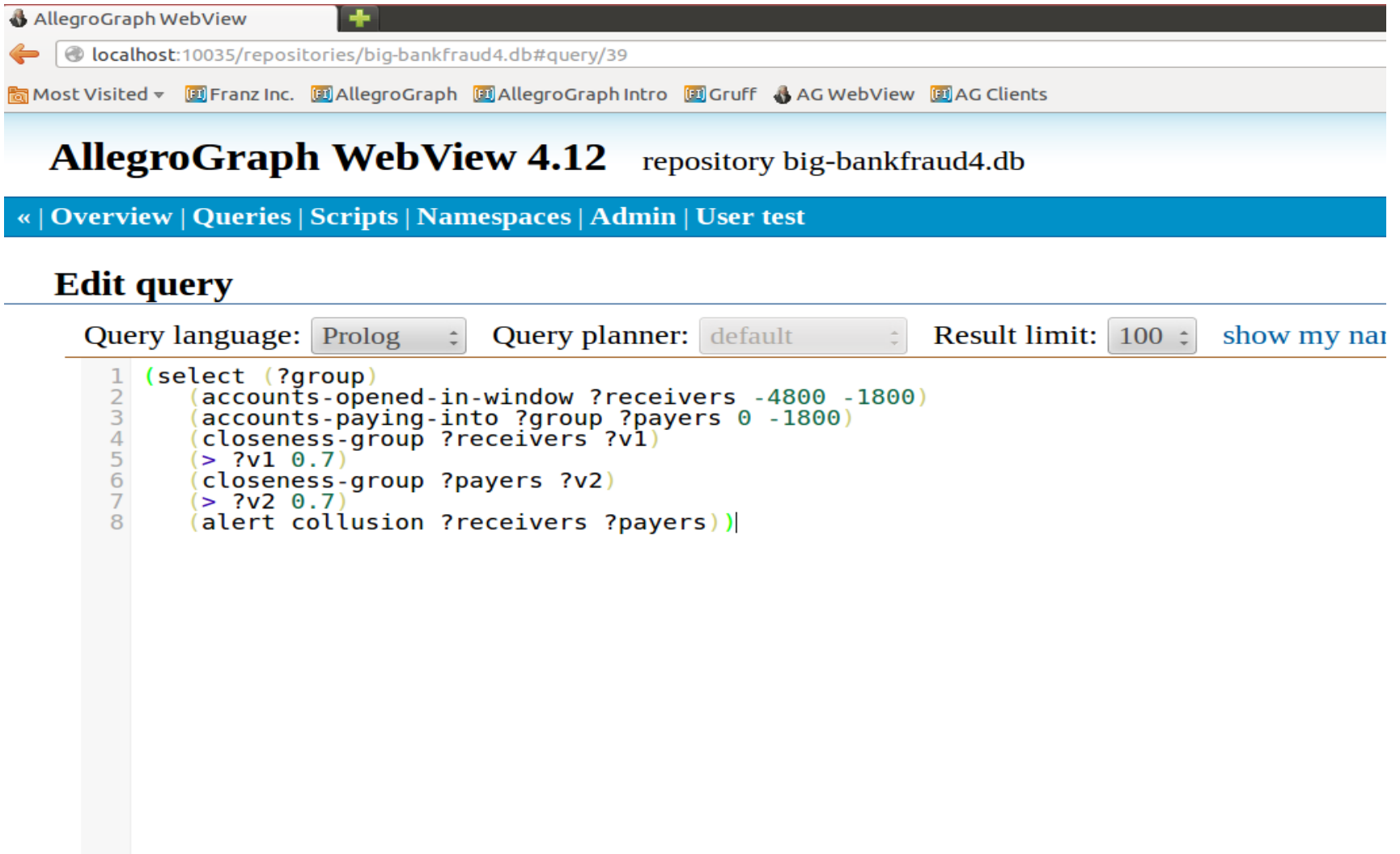

The screenshot shows the AllegroGraph WebView interface. The browser address bar displays `localhost:10035/repositories/big-bankfraud4.db#query/39`. The page title is **AllegroGraph WebView 4.12** repository `big-bankfraud4.db`. A navigation bar contains links: [« | Overview](#) | [Queries](#) | [Scripts](#) | [Namespaces](#) | [Admin](#) | [User test](#). Below this is the **Edit query** section. It features three dropdown menus: **Query language:** `Prolog`, **Query planner:** `default`, and **Result limit:** `100`. A [show my na](#) link is also present. The query editor contains the following code:

```
1 (select (?group)
2   (accounts-opened-in-window ?receivers -4800 -1800)
3   (accounts-paying-into ?group ?payers 0 -1800)
4   (closeness-group ?receivers ?v1)
5   (> ?v1 0.7)
6   (closeness-group ?payers ?v2)
7   (> ?v2 0.7)
8   (alert collusion ?receivers ?payers))|
```

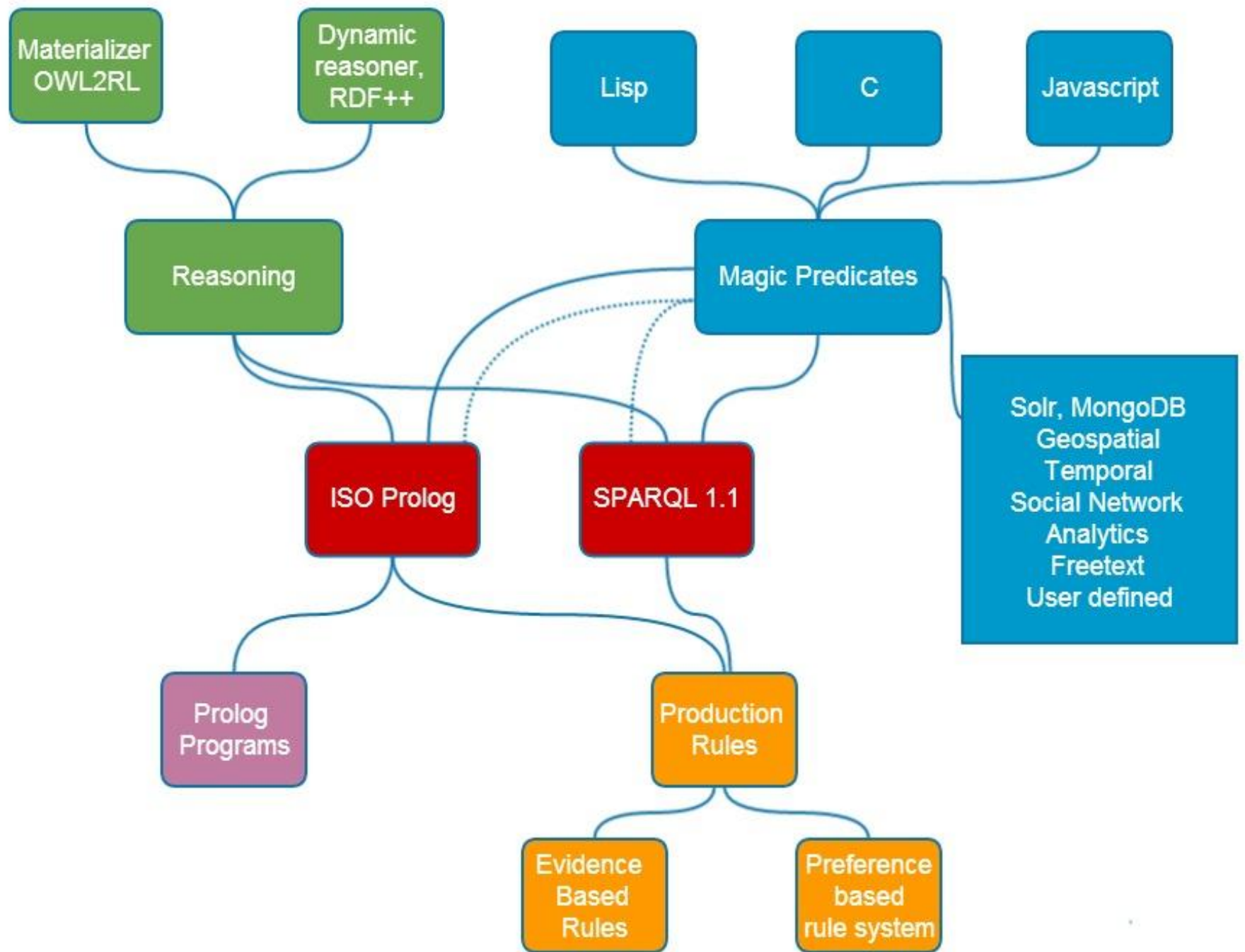

The End

